



EVSE Protocol Controller (EPC) Manual

<http://viridianeV.co.uk>

info@viridianeV.co.uk

1.

Introduction

1.1 ABOUT THIS DOCUMENTATION

PURPOSE OF THIS DOCUMENTATION

This Manual contains all the information you need for commissioning and using the Viridian EV EPC. They are intended for use by electrically skilled persons who commission the device.

SCOPE OF VALIDITY OF THIS DOCUMENTATION

This documentation is valid for all components of the Viridian EV EPC specified in this Manual and describes the delivery state as of Aug 2019.

THIS PRODUCT IS BASED ON THE IEC 61851 AND SAE J1772 INTERNATIONAL STANDARDS

2.

SAFETY INSTRUCTIONS

2.1 CAUTIONS & DANGERS

CAUTION: PLEASE OBSERVE THE SAFETY INSTRUCTIONS AND LEGAL NOTES

Installation requirements vary by country, state, and jurisdiction. It is the responsibility of the installer to ensure that the legal installation requirements are met.

DANGER: VOLTAGE HAZARDS

Contact with live components can result in serious injuries. Disconnect the system and all devices from the power supply before starting work.

2.2 FUSES

WARNING: UNDESIRABLE HEAT GENERATION OR FIRE DUE TO INADEQUATE FUSING.

The internal fuses are designed only to protect the device itself. The system installer and plant operator are responsible for the necessary line protection.

The relay outputs are not fused within the device. Without appropriate protection of the relay outputs, overloading can cause undesirable heat generation or even fire. The relay outputs are to be fused externally by the plant constructor.

2.3 REPAIRS

Repairs are not permitted. Defective devices must be disposed of in compliance with environmental requirements.

WARNING: DANGERS ASSOCIATED WITH UNAUTHORIZED OPENING OF THE DEVICE

Unauthorized opening of the device might place the user in danger or result in substantial damage to property.

CAUTION: INVALIDATION OF THE MANUFACTURER'S WARRANTY DUE TO UNAUTHORIZED ALTERATIONS TO THE DEVICE

Alterations to the devices are not permitted. Failure to observe this requirement shall constitute a revocation of the manufacturer's warranty.

3.

DESCRIPTION

3.1 EPC FEATURES

The Viridian EV EPC is a product which is intended for use in charging stations for electric vehicles.



DEVICE VERSIONS	<ul style="list-style-type: none"> • Viridian EV EPC s have part numbers in this format: E(1)(2)(3). • (1) indicates the maximum charging capacity, 16, 30, 32, 40, 50, 60, 63 or 80. • (2) is either "T", for tethered versions, or "F", for free cable/socket versions. • (3) indicates the hardware revision, e.g. "32" or "33"
AREAS OF APPLICATION & USE	<ul style="list-style-type: none"> • Controlling the charging procedure of electric vehicles • For communication with the electric vehicle according to IEC 61851 or SAE J1772
MOUNTING	Mounting onto standard rail according to DIN EN 60715
CONNECTION ELEMENTS	<ul style="list-style-type: none"> • Relay contacts for switching the load contactor, interlock, signalling contact (depending on model) • Operating voltage input • Vehicle interface
LED	Display of the operating state

3.2 APPLICATION EXAMPLE

The following shows a schematic application example of an electric vehicle charging post with Viridian EV EPCs. For example, feeder option A has a circuit breaker and an Insta contactor. Feeder option B has a circuit breaker and a SIRIUS power contactor.

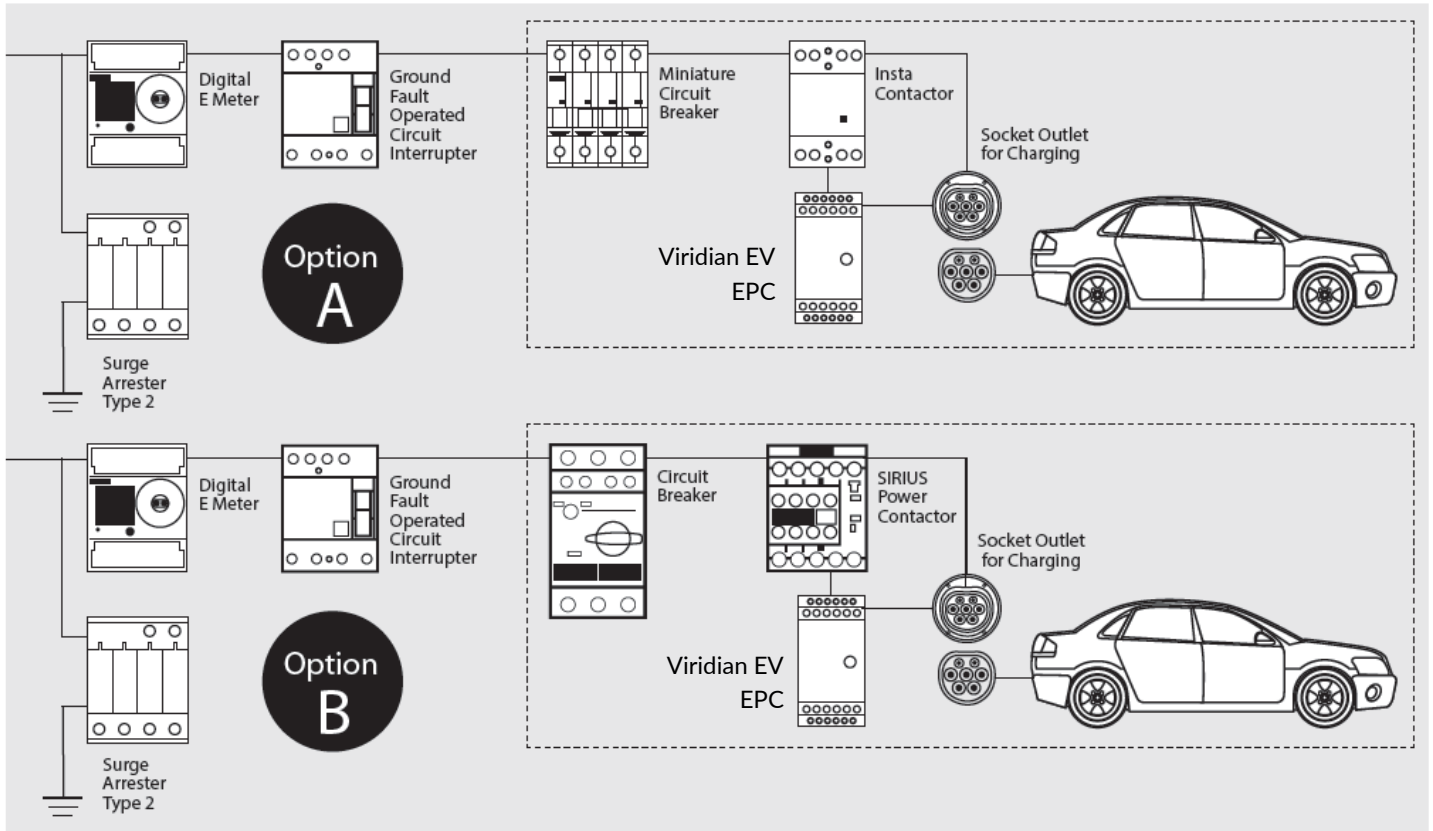

3.3 FUNCTION DESCRIPTION

STATES OF THE CHARGING VEHICLE

STATE A: Vehicle is not connected

STATE B: Vehicle is connected/not ready to receive energy

STATE C: Vehicle is connected/ready to receive energy/no ventilation of the charging area is required in buildings

STATE D: Vehicle is connected/ready to receive energy/ventilation of the charging area is required in buildings

STATE E: Short-circuit/power supply disconnected from electric vehicle/electricity is not available/other power supply problem

STATE F: EVSE is not available/other power supply problem

SEQUENCE OF CHARGING PROCESS

1. INITIALIZATION

After the operating voltage is applied, the module carries out initializations and function tests indicated by two LED flashing sequences (starting with and separated by a one-second solid white LED indication) and then waits for vehicle connection (indicated by flashing blue LED).

2. CHARGING PROCESS

The module waits for a charging cable or vehicle to be connected (state A) and continually blinks the blue LED. If an approved connecting cable has been connected (see Proximity) and state B is indicated by the vehicle, the module changes the LED to be steady-blue and activates the interlock.

After interlocking, the charge-enable relay P1/P2, P3/P4 or P4/P5 is activated (see Proximity) if the vehicle is signalling state C. The charging process is activated, and the LED is changed to steady-green. If state D is indicated (ventilation required) then charging and interlock are deactivated as the EPC does not provide a fan-enable mechanism, and the LED is changed to steady-red.

In the fault condition the charge-enable P1/P2, P3/P4, or P5/P6 and the interlock are deactivated and the LED is changed to continually blink red.

VENTILATION REQUIREMENT

WARNING: SUFFOCATION HAZARD WHEN CHARGING INDOORS

Without ventilation, a danger of suffocation can arise due to gas build-up with some battery types when charging indoors. If the charging process takes place indoors, forced-air ventilation should be installed. The Viridian EV EPC does not monitor the functionality of the forced-air ventilation.

PILOT CIRCUIT

The pilot circuit is used for the bi-directional exchange of information between the charging station and the vehicle. Via this signal, the charging station indicates to the vehicle the maximum permitted charging current which the vehicle can call up. The operational readiness of the charging station is also indicated. Via this signal, the vehicle indicates to the charging station its current state of charging readiness.

WARNING

Via the pilot signal, the EPC module specifies the maximum charging current that can be called up by the vehicle. This specified current must be consistent with the line protection configured for the charging device and the rest of the plant configuration. Failure to observe this notice can result in injury to persons or property damage.

PROXIMITY

With free cable installations the charging device detects the maximum current carrying capacity of the connected charging cable via the proximity signal. The activated charging output coded in the pilot signal is no greater than the current carrying capacity of the charging cable.

To ensure that the charging current does not exceed the rated capacity of the AC main power supply, there are different product variants which each provide different maximum charging current presets (Free/socket: 16A, 32A, and 63A. Tethered: 16A, 30A, 32A, 40A, 50A, 63A, 70A and 80A). The product version that is used must be designed corresponding to the installed line protection of the charging station.

The 32A and 63A versions of the free cable Viridian EV EPC are capable of generating different enabling signals depending on the current carrying capacity that is detected. For charging cables that have a current carrying capacity of 16A according to IEC 61851, relay P1/P2 is activated. The charging circuit that is activated by this must be designed with a suitable line protection for 16A. For charging cables that have a current carrying capacity of 32A according to IEC 61851, relay P3/P4 is activated. The charging circuit that is activated by this must be designed with a suitable line protection for 32A. For charging cables that have a current carrying capacity of 63A according to IEC 61851, relay P5/P6 is activated. The charging circuit that is activated by this must be designed with a suitable line protection for 63A.

INPUT CURRENT RESISTANCE INFORMATION

An Input Current (IC) resistance (or equivalent voltage) restricts the current maximum advertised by the EPC. The resistor (or voltage) is applied across the IC and OV terminals. It is recommended to use a resistor of 0.1% tolerance & power rating of 63mW or greater.

The IC values are as described below:

Max Current	IC Resistance (Ohms)	IC Equivalent Voltage (V)
80A	9090	4.5045
79A	8060	4.4481
78A	7320	4.3990
77A	6650	4.3464
76A	6190	4.3046
75A	5620	4.2447
74A	5230	4.1974
73A	4870	4.1482
72A	4530	4.0958
71A	4220	4.0421
70A	4020	4.0040
69A	3740	3.9451
68A	3570	3.9059
67A	3320	3.8426
66A	3160	3.7981
65A	3010	3.7531
64A	2870	3.7080
63A	2670	3.6376
62A	2550	3.5915
61A	2430	3.5423
60A	2320	3.4940
59A	2210	3.4424
58A	2100	3.3871
57A	2050	3.3607
56A	1960	3.3108
55A	1870	3.2578
54A	1780	3.2014
53A	1690	3.1413
52A	1620	3.0916
51A	1580	3.0620
50A	1500	3.0000
49A	1430	2.9424
48A	1370	2.8903
47A	1330	2.8541
46A	1270	2.7974
45A	1210	2.7376
44A	1180	2.7064
43A	1130	2.6526

Max Current	IC Resistance (Ohms)	IC Equivalent Voltage (V)
42A	1070	2.5845
41A	1050	2.5610
40A	1000	2.5000
39A	959	2.4477
38A	931	2.4107
37A	887	2.3503
36A	845	2.2900
35A	825	2.2603
34A	787	2.2020
33A	750	2.1429
32A	732	2.1132
31A	698	2.0554
30A	665	1.9970
29A	634	1.9400
28A	619	1.9117
27A	590	1.8553
26A	562	1.7990
25A	536	1.7448
24A	511	1.6909
23A	491	1.6465
22A	475	1.6102
21A	453	1.5588
20A	432	1.5084
19A	412	1.4589
18A	392	1.4080
17A	374	1.3610
16A	348	1.2908
15A	332	1.2462
14A	316	1.2006
13A	301	1.1568
12A	280	1.0938
11A	267	1.0537
10A	249	0.9968
9A	237	0.9580
8A	221	0.9050
7A	205	0.8506
6A	191	0.8018

Input resistance less than 100-Ω, MIN, will cause the EPC to reduce the advertised current capacity to 7A for five seconds after which charging and the interlock will be disabled and the EPC will enter into a forced Status A until input current resistance is increased.

3.4 LED DISPLAY & TROUBLESHOOTING

LED DISPLAY

The EPC has a 3-color LED for displaying operating states and fault conditions. The LED can be lit in blue, green, or red. The meaning of the individual displays is shown in the following tables:

LED	DESCRIPTION OF OPERATING STATE	
COLOUR	STATUS	
NOT LIT	NOT LIT	Device is not active, switched off <ul style="list-style-type: none"> No power supply
BLUE	FLASHING (1 HZ)	Device is waiting to be connected to an electric vehicle (Status A)
BLUE	STEADY	Electric vehicle connected, electric vehicle not ready for charging (Status B)
GREEN	STEADY	Charging process active (Status C)
RED	STEADY	Electric vehicle requires ventilation, charging deactivated (Status D)
RED	FLASHING (1 HZ)	Communication fault detected, charging deactivated (Status F)

4.

MOUNTING

4.1 MOUNTING ONTO STANDARD RAIL

1. Clip the device (a) vertically onto the horizontal DIN rail (b).
2. Swing the device downward until the unlocking slider on the DIN rail clicks into place.

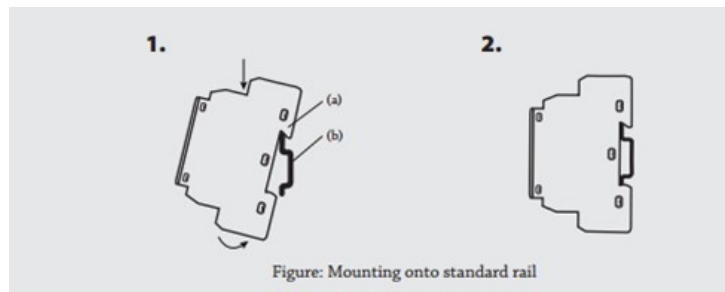

5.

CONNECTION

WARNING: UNDESIRABLE HEAT GENERATION OR FIRE DUE TO INADEQUATE FUSING

The internal fuses are designed only to protect the device itself. The system installer and plant operator are responsible for the necessary line protection. The relay outputs are not fused within the device. Without appropriate protection of the relay outputs, overloading can cause undesirable heat generation or even fire. The relay outputs are to be fused externally by the plant constructor.

WARNING: VIA THE PILOT SIGNAL, THE VIRIDIAN EV EPC CHARGING CONTROLLER SPECIFIES THE MAXIMUM CHARGING CURRENT THAT CAN BE CALLED UP BY THE VEHICLE.

This specified current must be consistent with the line protection configured for the charging device and the rest of the plant configuration. Failure to observe this notice can result in injury to persons or property damage

WARNING: THE CONDUCTOR CROSS-SECTIONS MUST BE DESIGNED CORRESPONDING TO A STANDARD-COMPLIANT SYSTEM CONFIGURATION.

The cables that are to be connected must be designed according to the respective type of circuit. Failure to observe this notice can result in injury to persons or property damage.

Depending on the device version the Viridian EV EPC charging controller is connected to the EVSE in the following methods:



5.1 CONNECTING TERMINALS & TERMINAL ASSIGNMENT

TETHERED CABLE

“Tethered” means that the charging cable is permanently connected to the EVSE. P3-P6 are not present and relay 1 will energize for all charging currents. Thus, the RCBO should be rated at the maximum current configuration of the EPC.

FREE CABLE / SOCKET VERSION



















“Free” means that the charging cable is not permanently connected and that the user is expected to provide their own. Relay 3 (P5/P6) is energized for cables connected which support 63A current capacities. Otherwise, relay 2 (P3/P4) is energized for cables connected which support 32A current capacities. Otherwise, relay 1 (P1/P2) is energized when the cable supports 16A current capacity.

STRIPPED LENGTH	PERMISSIBLE CONDUCTOR CROSS-SECTIONS OF TERMINALS	LINE TYPES ACCORDING TO AWG
 Single-Core	0,5 ... 2.5 mm ²	20 ... 14
 Finely Stranded	<ul style="list-style-type: none"> with core ends prepared: 0.5 ... 2.5 mm² without core ends prepared: 0,5 ... 2.5 mm² 	20 ... 14

NOTICE

The temperature stability of the cable used must be designed for at least for 75°C. Failure to observe this can result in injury to persons or property damage

EPC TERMINAL ASSIGNMENT

TETHERED VERSION	FREE CABLE VERSION	
	Solenoid Lock	Motor Lock
 <p>N NC L</p>	 <p>HL OV NC N NC T</p>	 <p>ML MU HF N NC T</p>
 <p>P2 P1 NC</p>	 <p>PP NC NC P2 P1 NC</p>	 <p>PP NC NC P2 P1 NC</p>
 <p>ExxTxx</p> <p>BLU - N/C GRN - CHG RED - ERR</p> 	 <p>ExxFxx</p> <p>BLU - N/C GRN - CHG RED - ERR</p> 	 <p>ExxFxx</p> <p>BLU - N/C GRN - CHG RED - ERR</p> 
<p>RD GN BL</p> 	<p>P3 P4 P5 RD GN BL</p> 	<p>P3 P4 P5 RD GN BL</p> 
<p>IC CP OV</p> 	<p>P6 NC NC IC CP OV</p> 	<p>P6 NC NC IC CP OV</p> 

EPC TERMINAL ASSIGNMENT

TERMINAL	DESCRIPTION
L (LINE)	This is where the AC 'live' or 'line' connection is made (90-264V @ 50/60 Hz AC)**
N (NEUTRAL)	This is where the AC 'neutral' connection is made (90-264V @ 50/60 Hz AC)**
0V (GROUND)	This is where the 'ground' connection is made**
HL (HATCH LOCK) / ML (MOTOR LOCK)	ExxF32: Provides 12V continuously to energise solenoid for hatch lock (HL) ExxF33: This provides 12V 300mA for 500 ms to engage the lock for motorised locks (ML)
MU (MOTOR UNLOCK)	ExxF32: This provides return path for the solenoid circuit (0V) ExxF33: This provides 12V 300mA for 500 ms to disengage the lock (MU)
HF (LOCK FEEDBACK)	Reads lock feedback for motorised locks
NC (NOT CONNECTED)	
P1	Relay 1 live from RCBO*
P2	Relay 1 coil on the contactor*
P3	Relay 2 live from 32A RCBO
P4	Relay 2 coil on the 32A contactor
P5	Relay 3 live from 63A RCBO
P6	Relay 3 coil on the 63A contactor
PP (PROXIMITY PIN)	This connects to the PP connector on the IEC61851 EVSE connector
GN (GREEN LED)	For external LED connection for green indication (5V 30mA)
BL (BLUE LED)	For external LED connection for blue indication (5V 30mA)
RD (RED LED)	For external LED connection for red indication (5V 30mA)
CP (CONTROL PIN)	This connects to the CP connector on the IEC61851/J1772 EVSE connector
IC (INPUT CURRENT PIN)	This connects to one side of the IC resistor, switch, or dial (the other side to 0V)

* On tethered installations the RCBO and contactor should be rated according to the maximum current capacity of the EPC. On free-cable installations the RCBO and contactor should be rated 16A.

** DC capable: For 120-370V DC on L, connect N to ground (0V).

5.2 230 V AC POWER SUPPLY

WIRING EXAMPLE 230 V AC

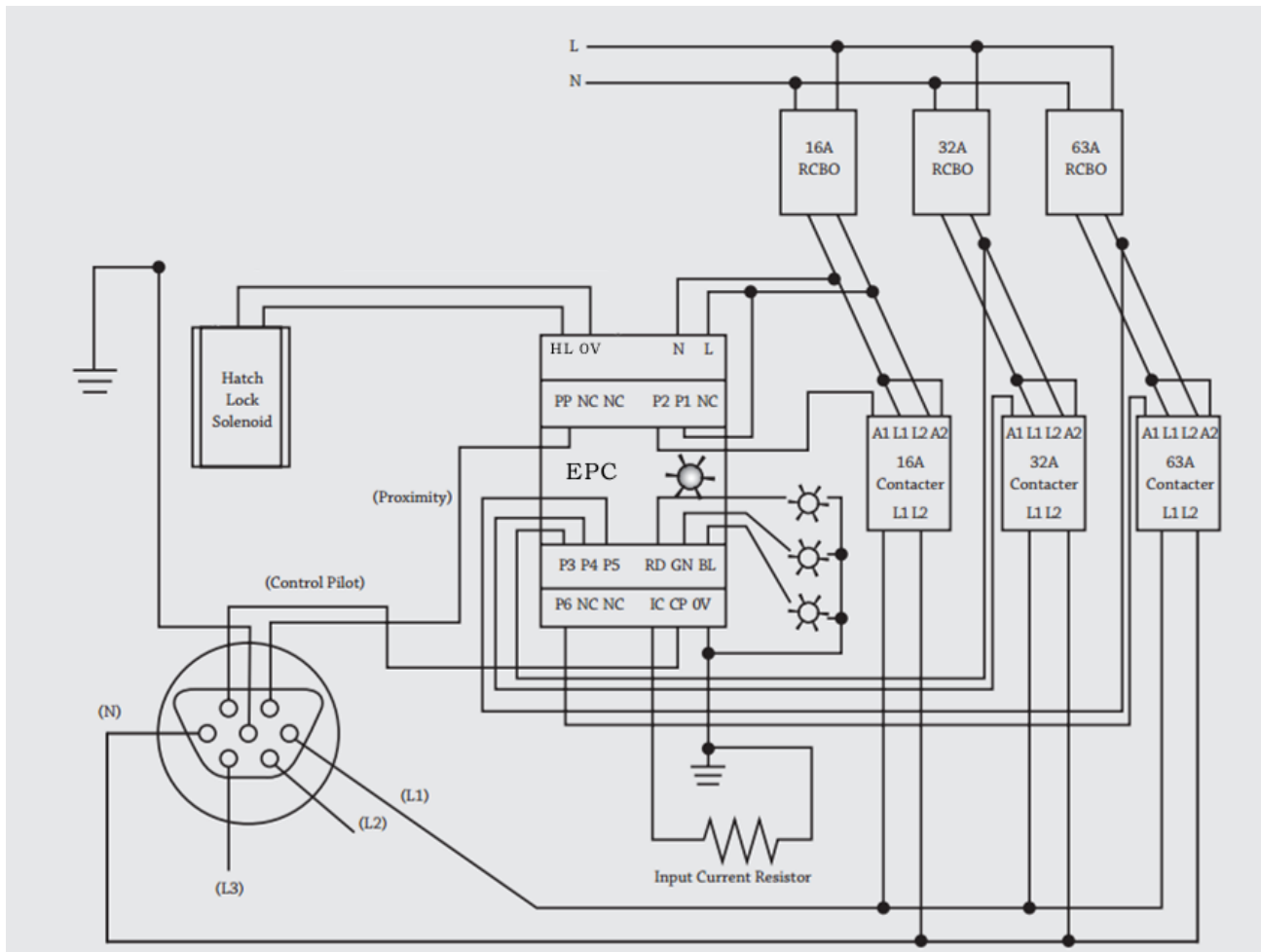

WARNING: THE EXTERNAL CONTACT BLOCKS USED MUST BE FLOATING AND SAFELY SEPARATED FROM UNSAFE CIRCUITS.

Failure to observe this can result in injury to persons or property damage.

5.3 FUNCTIONAL GROUNDING

VEHICLE INTERFACE ACCORDING TO IEC 61851

1. Connect the terminals "CP" and "PP" (on free versions only) directly to the vehicle connector.
2. First connect the ground connection of the vehicle interface to the 0V reference point and then route this potential from there

DANGER: NEVER USE THE TERMINALS OF THE VIRIDIAN EPC CHARGING CONTROLLER AS A 0V REFERENCE POINT.

Always route this externally from the device! The 0V reference point within the plant must be dimensioned according to the anticipated current of the plant itself. The EPC connection to the 0V is only a functional ground. Failure to observe this notice can result in electric shock or damage to property.

5.4 RELAY OUTPUTS

We recommend single fusing with 230/400 V 10 kA circuit breakers, 1-pin, C, 2 A, T = 70 mm

SHUTDOWN OF POWER BRANCH

According to IEC 61851, a shutdown of the power branch on completion of the charging process within 3 s is required. A shutdown of the power branch on transition from state C to state A is required within 100 ms. The Viridian EPC deactivates the relay output within this requirement after detecting the shutdown criterion.

WARNING: THE SHUTDOWN OF THE POWER BRANCH, IN PARTICULAR THE POWER CONTACTOR, IS TO BE DESIGNED IN SUCH A WAY THAT THE ENTIRE IMPACT CHAIN DOES NOT EXCEED THE REQUIRED 100 MS.

Failure to observe this notice can result in death or serious physical injury.

6.

SERVICE & MAINTENANCE

6.1 REPLACING THE DEVICE

MAINTENANCE

The Viridian EPC charging controller is maintenance-free.

WARNING: THERE ARE NO USER-REPLACEABLE FUSES WITHIN THE EPC

VIRIDIAN EPC REPLACEMENT

REQUIREMENT: Ensure that the plant and the device itself are de-energized.

DANGER: VOLTAGE HAZARDS

Contact with live components can result in serious injuries. Disconnect the system and all devices from the power supply before starting work.

PROCEDURE:

1. Disconnect the wiring from all EPC connector terminals.
2. Disassemble the device by pulling the locking slider on the back of the device down and swivel the device away from the DIN rail and remove it.
3. Install the new device by clipping the top locking guide onto the DIN rail and swinging it down until the locking slider clicks into place.
4. Reconnect the wiring.
5. Switch on the power supply for the device and the main power for the unit feeder again.

6.2 CLEANING

Cleaning of the device is not intended or permissible.

7.

DIMENSIONAL DRAWINGS

